



FASTEST[®]



COREMAX[®]

High Flow Access Valve System
for Rapid Evacuation of HVAC-R
Systems using Schrader Valves

fastestinc.com/CoreMax





FASTEST[®]

Global Leader in Industrial Sealing Connection Technology

HVAC-R | Vehicle Systems | Compressed Gas | Medical Life Science | Aerospace

At FasTest, our mission is to reduce our customer's manufacturing costs, improve safety and lower the environmental impact from refrigerant emissions.

As an industry leader of Sealing and Connection Technologies, FasTest offers standard products for most ports/threads/tubes, and a dedicated team of Custom Design Experts to engineer optimized solutions for demanding applications. Connect fast, seal reliably, test safely.



BROAD OFFERING

Extensive standard and Custom Engineered Solutions.



INTELLIGENT TOOLS

Sensing & data generation tools that support process automation.



APPLICATION EXPERTS

Optimized solutions, tailored to your unique needs.



GLOBAL SUPPORT

Global distribution network provides local, responsive support.



SUPERIOR QUALITY

ISO 9001 Certified; Robust tools improve the quality of your product.

HVAC-R OEM ACCESS PORT SYSTEMS

COREMAX[®]

Faster Processing of Systems Using Schrader Type Valves



PORTMAX[™]

Rapid Evacuation of Large Capacity Systems



ZEROMAX[™]

Easy Access for Small Systems using Processing "Stub" Tubes



The CoreMax® System eliminates process tubes and Schrader valves resulting in dramatically faster evacuation times, improved quality, greater throughput, and less rework and maintenance costs.

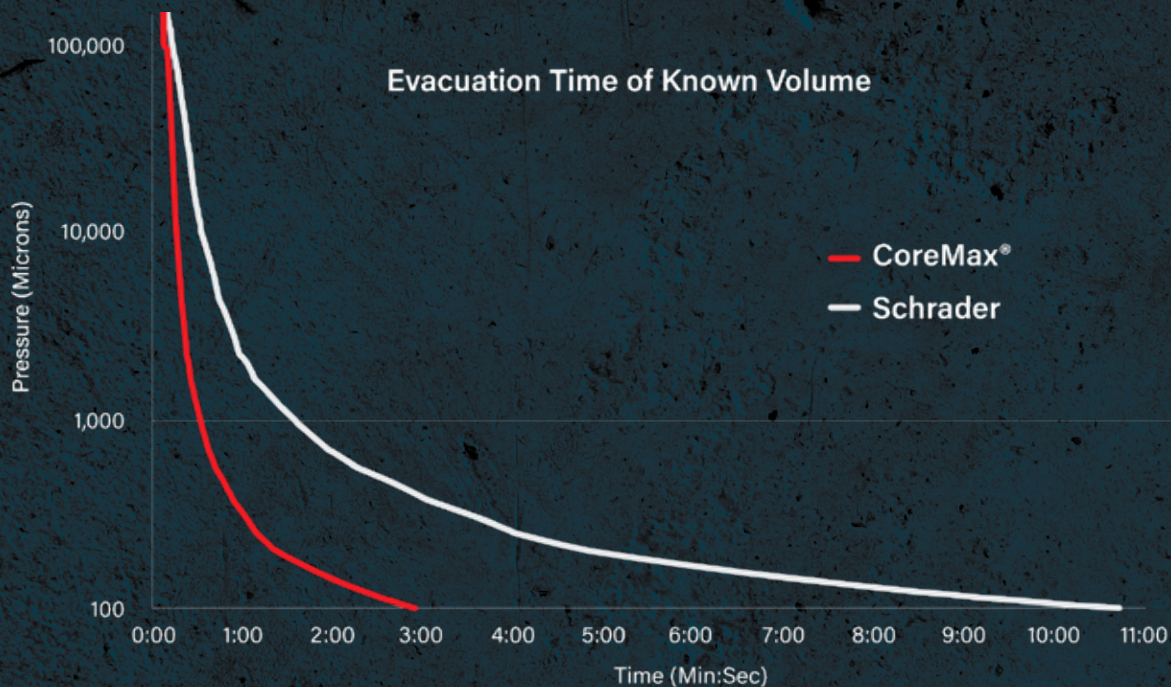

▶ Proven Productivity Improvement

- Highest flow capacity
- Improve takt time
- Easy-to-use production tooling system
- Increase first pass yield

▶ Reduces Total Processing Cost

- Dramatically faster evacuation
- Fewer processing tools required
- Fewer connections per unit processed
- Less tool maintenance

▶ Highest Quality

- Reliable leak-free valve for dramatically improved sealing
- Six Sigma (6σ) quality level
- ISO 9001:2015 certified

FASTER PROCESSING OF SYSTEMS USING SCHRADER TYPE VALVES



**UNITARY AC
PACKAGES &
HEAT PUMPS**



**SELF CONTAINED
DISPLAY CASES**



**REFRIGERATED
AIR HANDLER /
CONDENSING
UNITS**

Faster Processing
Superior Sealing

COMMERCIAL ICE MAKERS



POOL HEAT PUMPS



ANYWHERE A RESTRICTIVE & LEAK PRONE SCHRADER VALVE IS USED



COREMAX[®] SYSTEM

The CoreMax Access Valve & Seat System provides up to five times greater processing flow than common Schrader valves and has dramatically improved sealing performance. Plus, it provides easy and reliable system accessibility compared to stub tubes and leak prone "Saddle Valves".

High Flow Access Valve



Processing Tools



- An entire processing solution for HVAC-R applications that has millions of units installed globally
- Provides increased efficiencies and throughput, resulting in reduced total processing cost
- Maximum flow area results in high conductance during evacuation process
- Proven family of tools specifically designed for manufacturing and service that reduce plant tooling costs by up to 15%
- Ergonomic tools reduce operator fatigue and overall manufacturing costs
- Reduce rework from leaking Schrader valves by up to 99%
- The 1/4" 45° flare (7/16-20 thread) is compatible with standard refrigeration tooling, hoses, and swivel fittings
- Use with FasTest Evacuation Cart to optimize evacuation

Industry's Fastest Evacuation System

High Flow Access Valve



Processing Tools

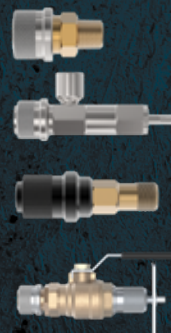

Evacuation Cart



The Refrigeration Industry's Highest Flow Access Valve

Core design eliminates packings/seals resulting in a reliable seal... every time.

Safe automatic shut-off valve prevents accidental refrigerant discharge.

High flow seat assures maximum flow, available in Saddle Mount & threaded configurations for easy installation.

Leak/Proof Test

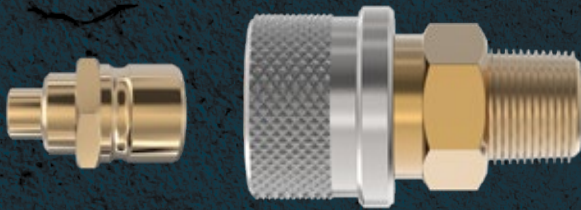

Quick Filling

Pressurize & empty system quickly through large flow path.

Evacuation



Fast Evacuation

Unobstructed flow path yields maximum flow.

Charge

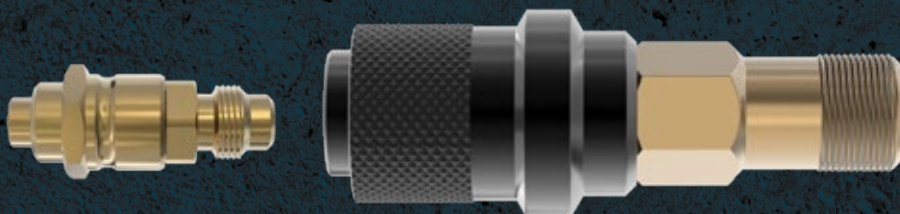

Safe Charging

Charge Tool latch will not accidentally disconnect when under pressure.

FIELD SERVICE TOOLS

For Installation and Service Technicians

Gain access to the refrigerant system for servicing. Designed to provide installation & service technicians with tools that can be used to perform multiple tasks - refrigerant reclaim, leak test, evacuation, charge and replace a CoreMax® Access Valve Core.

SnapMate™ Service Tool

- Leak Test
- Evacuate
- Charge



Connects to both CoreMax® and Schrader valve 1/4" Flare fittings

Core Removal Tool

- Replace Core with minimal refrigerant loss

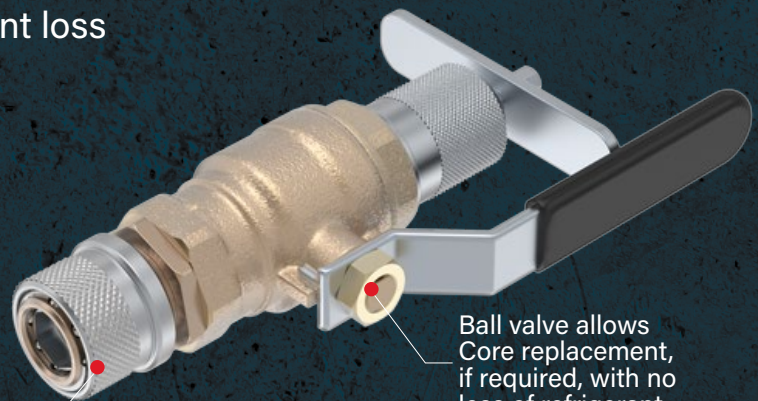

Ergonomic ball latch for easy connection and will not release when system is under pressure.

Ball valve allows Core replacement, if required, with no loss of refrigerant.

EVACUATION CART

Optimized for CoreMax®

Reducing evacuation time requires both a high flow Access Valve/Connector system AND a properly designed evacuation system... a TOTAL SOLUTION. FasTest's new turn-key Evacuation Cart is optimized for the CoreMax® System - the fastest evacuation possible, at the lowest cost.

Large diameter, high conductance hoses.

An optimized system of matched components that will result in the fastest evacuation time possible.

Mobility for easy maneuverability around large refrigeration packages with large, industrial grade lockable casters.



- Real time evacuation tracking & data capture for use in quality, control and performance validation.
- Self diagnostic capability to verify proper operation, e.g., no leaks.
- Data analysis capability facilitating ongoing process improvement, reduced takt time, improved evacuation quality and lower total processing cost.
- Automated operation, automatic shut-off, isolation, decay test, etc.

A turn-key system, from FasTest with a warranty and factory support.

CoreMax[®] / HIGH FLOW Access Valve

Access Valve System for Maximum Flow & Faster Processing.



- 1 Specifically designed for refrigeration applications maximizing flow and robust sealing technology
- 2 The CoreMax[®] Core utilizes one elastomeric seal to seal both the valve and the joint between the Core and the Seat - metal-to-metal seal between the Core and Seat to ensure a complete seal.
- 3 The Core pin position is manufactured to exact tolerances for constant sealing and maximum valve opening for the highest flow available - conforms to ARI standard 720 for pin height
- 4 CoreMax[®] has a 7/16-20 45° flare which is the industry standard for access valves, so all standard service tools can be used

SPECIFICATIONS

Seat Styles	Stub Tube, Saddle Mount, Panel Mount, NPT
Pressure Rating	10 millitorr (micron) vacuum to 750 psi (51.7 bar)
Leak Rating	less than 0.018 oz/yr of R-410A
Flow Diameter	Valve Core: Ø 0.21" (5.3mm) nominal (must use OEM SnapMate™ Tool - PN: SCP062H) Seat: Ø 0.31" (7.9mm) nominal seat size dependent (must use Core Insertion Tool - PN: SCFT10)
Flow Rate*	Vacuum: 4.9 SCFM (7.9 Nm ³ /hr) (using use OEM SnapMate™ Tool - PN: SCP062H) Pressure: up to 35 SCFM (56.4 Nm ³ /hr) (using use Core Insertion Tool - PN: SCFT10)
Material	Brass, Neoprene*
Tightening Torque	8 ft-lbs (11 N-m) (Valve into Seat Torque) Note: FasTest recommends using SCFTM01 Manual Torque Wrench or SCFTP05/SCFTP06 Electric Torque Wrenches

*Flow rate indicated is through the valve core using the OEM SnapMate connector. Processing/flowing through the Seat only using the Core Insertion Tool will provide significantly more flow capacity.

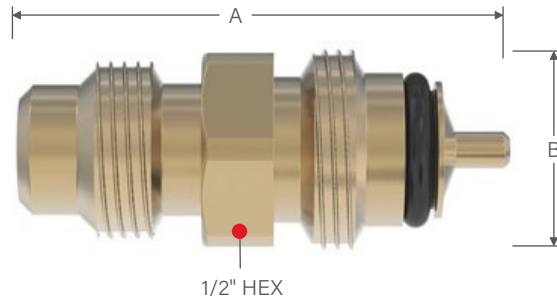

Ordering Information	Dimensions	
Part Number	A	B
CoreMax® Valve Mates with CoreMax® Seat for Complete Access Valve		
SCCA07H	1.00 (25.4)	1.00 (25.4)

Dimensions: inch (mm)

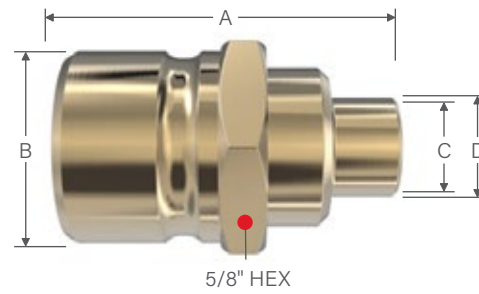

Ordering Information			Dimensions					
Style	Size	Part Number	A	B	C	D	Installed Length*	
Stub Tube	1/4	SCH0730A01	1.00 (25.4)	0.59 (17.5)	0.26 (6.6)	0.31 (7.9)	1.26 (32.0)	
	3/8	SCH0730A03			0.38 (9.7)	0.43 (10.9)		
Saddle Mount	3/8 - 0.38 Hole	SCH0730B02	0.92 (23.4)		0.28 (.71)	0.37 (9.4)		1.33 (33.8)
	1/4 - 0.22 Hole	SCH0730B03			0.17 (4.3)	0.22 (5.6)		
	1/4 - 0.25 Hole	SCH0730B04			0.18 (4.6)	0.25 (6.4)		
Panel Mount	1/4	SCH0730C03	1.29 (32.8)		0.26 (6.6)	0.35 (8.9)	1.33 (33.8)	
	3/8	SCH0730C04		0.38 (9.7)	0.44 (11.2)			
NPT	1/4	SCH0730E01	1.15 (29.2)		0.31 (7.9)	-----		

Dimensions: inch (mm)

* Installed length is CoreMax® Valve and CoreMax® Seat torqued together.



PROCESSING TOOLS

MBE Leak Test Tool

PN: SCM062W



APPLICATION

High flow connection tool with no flow restriction. Used to maximize flow through the seat. Pressure interlocks prevent sleeve actuation under pressure.

- Ergonomic ball & sleeve action.
- Pressure interlock system will not disconnect under pressure.
- 3/8 NPT media port.

SPECIFICATIONS

Pressure	10 millitorr (micron) vacuum to 700 psi (48.2 bar)
Flow	Ø 0.31" (7.9mm) nominal, Seat size dependent
Flow Rate	Pressure: 35+ SCFM (56.2 Nm ³ /hr), Seat size & pressure dependent.
Dimensions	2.00" (50.8mm) long x Ø 1.22" (31mm)
Material	Stainless steel, Brass, Neoprene*

OEM SnapMate Tool

PN: SCP062H



APPLICATION

Internal valve opens automatically upon connection and closes upon disconnection and has internal actuation pin to open CoreMax® Valve. Designed for OEM processing.

- Ergonomic push/pull sleeve action.
- Pressure interlock system will not disconnect under pressure.
- 3/8 NPT media port.

SPECIFICATIONS

Pressure	10 millitorr (micron) vacuum to 700 psi (48.2 bar)
Flow Diameter	Ø 0.21" (5.6mm) nominal
Flow Rate	Vacuum: 4.9 SCFM (7.9 Nm ³ /hr), Pressure: up to 30 SCFM (48.0 Nm ³ /hr), Seat size & pressure dependent.
Dimensions	3.4" (86.4mm) long x Ø 1.25" (31.8mm)
Material	Black Oxide steel, Brass, Neoprene*

Insertion Tool

PN: SCFT10



APPLICATION

For high flow evac processing through the Seat only. Insert core after processing.

- Ergonomic ball & sleeve action.
- 3/8 NPT media port.

SPECIFICATIONS

Pressure	10 millitorr (micron) vacuum to 700 psi (48.2 bar)
Flow Diameter	Ø 0.31" (12.7mm) nominal, Seat size dependent
Flow Rate	Vacuum: up to 12.5 SCFM (7.9 Nm ³ /hr), Pressure: up to 35+ SCFM (56.2 Nm ³ /hr), Seat size & pressure dependent.
Dimensions	4.68" (119mm) long x Ø 1.22" (31mm)
Material	Stainless steel, Neoprene*

SERVICING TOOLS

SnapMate™ Service Tool

PN: SCTA07H



APPLICATION

Internally valved for refrigerant containment upon disconnection.

- Collet design locks securely into CoreMax® and common Schrader® valves with 1/4" 45° Flare with 7/16-20 thread
- 90° termination port for best ergonomics of small connection tool
- 3/8 NPT media port.

SPECIFICATIONS

Pressure	vacuum to 625 psi (43 bar)
Flow Diameter	Ø 0.21" (5.6mm) nominal
Flow Rate	Vacuum: 4.5 SCFM (7.2 Nm ³ /hr), Pressure: up to 26 SCFM (41.8 Nm ³ /hr), Seat size & pressure dependent.
Dimensions	0.93" (23.6) long x 1.94 (49.3)
Material	Stainless Steel, Brass

Removal/Replace Tool

PN: SCFT20A

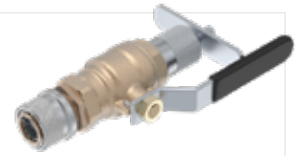

APPLICATION

For removing and replacing CoreMax core when the system is under pressure. Twist out core, slide shaft back, close ball valve and remove back cap to access the core.

- Ergonomic ball & sleeve action.
- Shaft moves in and out to remove/insert core.
- 3/8 NPT media port.

SPECIFICATIONS

Pressure	vacuum to 600 psi (41.4 bar)
Flow Diameter	N/A
Flow Rate	N/A
Dimensions	5.75" (146mm) long x Ø 1.55" (39.4mm) [Does not include Handle]
Material	Stainless steel, Brass, Steel, Teflon, Aluminum, Neoprene*

CoreMax[®] Torque Tools

Pistol Grip Torque Gun



PN: SCFTP0620

- Light weight and ergonomic design to reduce torque reaction resulting in reduced fatigue & injury
- Programmable - easy adjustment on site via USB port using ICS software (pre-programmed to 8 lb-ft (10.9 N-m) at 200 RPM)
- Long battery life with LED "Fuel Gauge"; 20V, 5 Ah lithium ion battery offers long lasting life with quick recharging

In-Line Torque Gun



PN: SCFTP0520

- Pre-programmed to CoreMax specifications of <200RPM and 8ft-lbs torque
- Use with CMFT375312DS Socket to torque Plug
- Use with CMFT37550DA Adapter & CMFT5011875DS Socket to torque Dust Cap

Torque Wrench Accessories



Charger

SCFTP06C



Battery

SCFTP06B



Drive Head

SCFTP16



Internal Socket

5543A87



Socket Adapter

SCFTP61

Manual Torque Wrench



PN: SCFTM01

- Break away torque wrench pre-set to proper torque of 8ft-lbs (10.9 N-m)
- Manually twist wrench to pre-set torque



3/8" Drive x 1/4" Socket

CMFT375312DS

CoreMax® Accessories & Rebuild Kits

Oiler

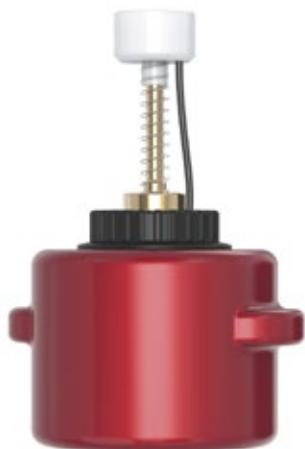

PN: SCL321

- Custom nest to oil CoreMax core with overflow containment
- Reservoir has check valve to keep small amount of oil available for lubrication
- Oil containment keeps contaminants away and minimizes oil exposure to atmosphere
- Pump to fill reservoir

Core Valve Load Tool



PN: SCFTL10

- Use to properly install valve core (SCCA07H) into Core Insertion Tool (SCFT10) or Core Valve Removal Tool (SCFT20A) prior to making processing connection.

Rebuild Kits

Part Number	Rebuild Kits
SCPR50	2022 SnapMate OEM Rebuild Kit (components for 25 connectors)
SCPR10	Pre-2022 SnapMate OEM Rebuild Kit (components for 25 connectors)
SCRA07H	SnapMate Service Tool rebuild, 50 main and 25 internal seals
SCFTR10	Core Insertion Repair, 10 Repairs
SCFTR20A	Core Removal Repair, 1 Repair

Bulk Seals

Part Number	Bulk Seals
SCPB10	SnapMate OEM, 50 Main Seals
SCBA07H	SnapMate Service Tool, 50 Main Seals
SCFTB	MBE, Core Insertion, Core Removal, 20 Main Seals

Evacuation Cart Overview

Optimized for the CoreMax® Access Valve System - A Total Evacuation Solution.



The Evacuation Cart is a turn-key, optimized solution with real-time tracking and data capabilities directly from FasTest.

Designed to integrate with the PortMax™, CoreMax®, and ZeroMax™ access port systems.

- OR -

Can be used with common refrigeration system access valves.

- Turn-key, integrated vacuum system of properly matched components.
- Set target vacuum, vacuum decay limits and monitor in real time. Store and download evacuation data records.
- Facilitates process improvement and optimization.
- Reduce evacuation time leading to improved production "Takt Time".
- Lockable storage cabinets safely store components when not in use. Full line of accessories to meet your needs.
- Mobile cart can be used in plant, at installation site and for service.
- Easy to use intuitive design and durable construction will provide years of reliable service.

EVACUATION CART

Packed with "Smart" features that streamline evacuation, record keeping and productivity.

The system is driven by a rugged, full-featured wireless vacuum gauge that is paired with an industry leading app. The system has unprecedented features that identify issues with moisture or leaks, and document the entire process with powerful reporting features not found in any other vacuum application.



Real time data monitoring.

Track & Display

Track and display the evacuation and vacuum decay test in real time.

Data Capture

Store data records for internal documentation, process validation, and customer documentation.

Process Optimization

Evaluate evacuation traces/data to recognize opportunities for improvement.

Highest accuracy & resolution available.



Wireless Connectivity

Gauge pairs with pre-installed app to accurately monitor and track evacuation and vacuum decay processes.

Automatic Notifications

Automatic notifications of evacuation process with leak check feature. Export data as graphical PDF or CSV.

EVACUATION CART



Multi-Purpose Docking Ports

- Rugged FasTest connectors and integral “Docking Ports” keep moisture and contamination out the system when not in use.
- Easily perform a system integrity leak test before beginning an evacuation.

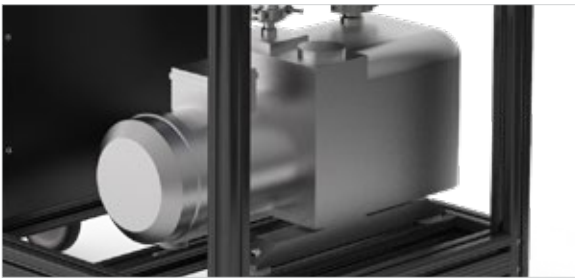

High Performance Vacuum Pump

- Industrial grade, two-stage rotary vane vacuum pump assures rapid evacuations and long service intervals.
- High quality isolation valve allows for vacuum decay test without disconnecting hoses or closing access ports/valves.

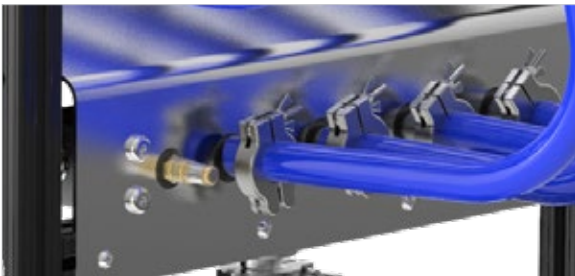

4-Port Manifold & System Test Port

- Connect up to four individual hoses with industry standard KF vacuum fittings assure quick leak tight connections and rapid evacuations.
- Test port allows connection of vacuum gauge for system leak check.



Long Life & Easy to Use

- Rugged construction will provide years of reliable service.
- Ergonomic tablet computer location with USB port.
- Lockable storage cabinets to keep tools safe.
- Convenient work surfaces.

HOW TO ORDER

Contact FasTest for assistance with Evacuation Cart configuration at fastsales@fastestinc.com.

Evacuation Cart

Part Number	Description
CECBA12J	Evacuation Cart, Manual, 12 cfm model J vacuum pump, 110v/60Hz Single Phase
CECBA12N	Evacuation Cart, Manual, 12 cfm model N vacuum pump, 110v/60Hz Single Phase
CECBA23N	Evacuation Cart, Manual, 23 cfm model N vacuum pump, 110v/60Hz Single Phase

INCLUDES: Mobile evacuation cart with 4 port manifold, heavy duty locking casters, 3 lockable storage drawers, isolation valve for pressure decay test, vacuum pump (110v/60Hz single phase motor) with oil mist filter, system is wired for Core-n-play operation.

DOES NOT INCLUDE: Hoses, Connectors, adapter fittings or vacuum gauge and tablet computer required for process monitoring & data capture which must be ordered separately. Shipping cost not included (FOB, FasTest Inc. dock).

Evacuation Hoses

Part Number	Description
CECHOSE10	Hose, KF16, 1.0 meter (3.3') long
CECHOSE20	Hose, KF16, 2.0 meter (6.5') long
CECHOSE30	Hose, KF16, 3.0 meter (10') long
CECHOSE40	Hose, KF16, 4.0 meter (13') long
CECHOSE50	Hose, KF16, 5.0 meter (16') long
AE002	Connector Kit KF-16/KF-16 w/two S10752 Clamps (Use to join "daisy chain" two hoses)

Connection to CoreMax Connector Tools (SCFT10 or SCP062H)

Part Number	Description
SCFT10	CoreMax Valve Core Insertion Tool (Use to evacuate through CoreMax Seat for maximum flow)
AE007	Male Fitting, KF16 x 3/8 Male NPT (for Core Insertion Tool to hose)
AE016PE01	Adapter, PortMax x CoreMax (Screw into docking port to dock CoreMax Tools)
AEKF16C	Clamp, KF-16 (Aluminum, use to join KF16 hose fitting to KF16 Connector Tool fitting)
SCFTR10	Repair Kit for Core Insertion Tool (10 Repairs)
S1016N70	CoreMax Valve Core Insertion Tool Main Seal (10 Seals)

Vacuum Gauge & Tablet Computer

Part Number	Description
CECGAB	Vacuum Gauge, Wireless, BVPRO (Includes 1 Gauge Coupler (CECGABCP1) to connect to 1/4 flare fitting)
AE001	Tablet computer (comes loaded with App to pair with CECGAB wireless vacuum gauge for monitoring)

Spare Parts & Service Items

Part Number	Description
AE009	Vacuum pump oil for JB Industries Vacuum Pump (Quart)
AE011	Vacuum pump oil (Industrial Grade) for Navac Vacuum Pump (Quart)
1314B50	Replacement O-Ring (#314) for Hose KF-16 fitting (Pack of 10)
AE003	Protective Plastic Cap for KF-16 Hose Fittings (Pack of 4)

FASTEST GLOBAL DISTRIBUTION NETWORK

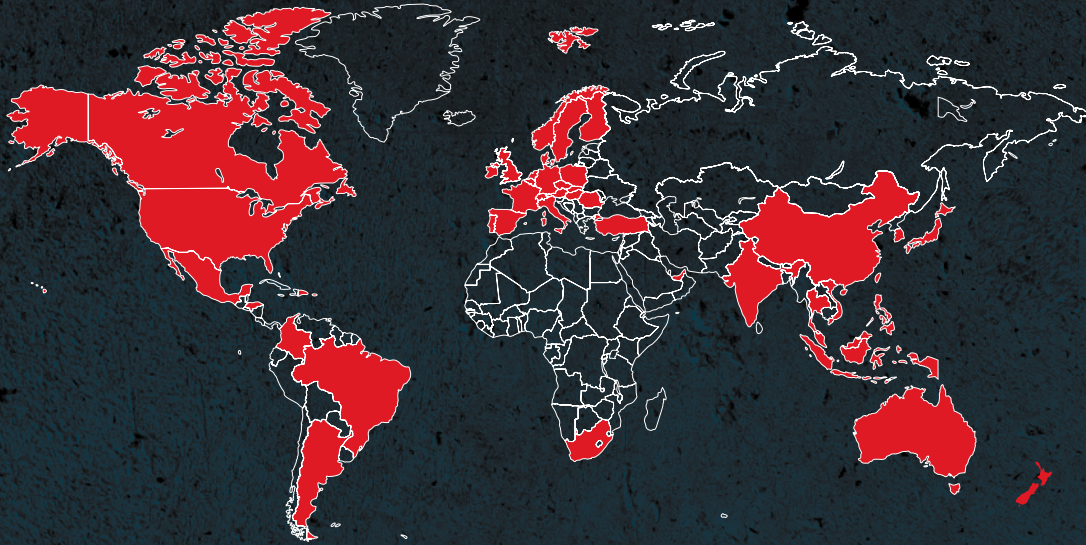

Interested in Learning More? Have Questions?

Contact Us.

fastsales@fastestinc.com
651.251.9741



Designed in the U.S.A.

Headquarters | USA

1646 Terrace Drive, Roseville, MN, 55113-1317
Phone: 651.645.6266 • Fax: +1.651.645.7390 • www.fastestinc.com

Shenzhen | China

Room#1013,1015, A9 Building, Tianrui Industrial Park
No.35 Fuyuan 1st Road, FuHai residential district,
Baoan Shenzhen, China 518103
(755) 27084905 • fastsalescn@fastestusa.cn