

60 & 70 Series Connectors

DESCRIPTION: Sleeve Activated Connectors for Sealing Male Threads and Formed Tube Ends.

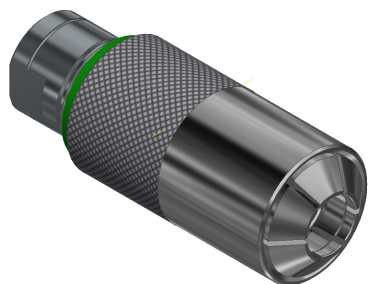

60 Series for
Male Threads



70 Series for
Formed Tubes

Please thoroughly read the instructions prior to operating the connector. This connector is designed to provide a safe, reliable leak-tight seal and connection when properly maintained and operated.

The connector is designed to mate with a specific application. Verify the application prior to the introduction of pressurized media. Use only in a safe environment.

Connectors are NOT designed for permanent connections and are for temporary connections only.

- Installation
- Operation
- Main Seal Replacement
- Connector Maintenance
- Safety Warnings - Guidelines

DO NOT EXCEED pressure rating as marked on connector or corresponding literature. Before using, verify that this pressure rating is within your working pressures.

INSTALLATION:

1. Connect media hose/fitting to the termination port on connector.
 - a. Pipe tape and or thread sealant is recommended.

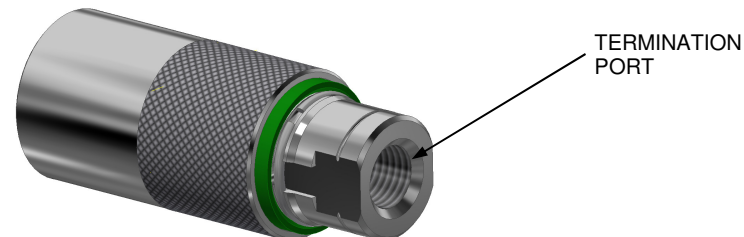

OPERATION:

1. Slide/pull sleeve manually backwards, this will allow collets/jaws to open.

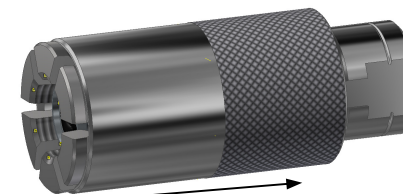

TEST PIECE
EXAMPLE

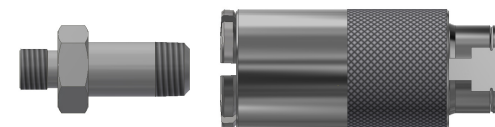

2. Insert male end of the component to be tested into collets/jaws and push connector onto test piece.

- a. NOTE: CONNECTOR OPERATES BEST IF YOUR HAND ISN'T ON SLEEVE, HOLD THE BODY AND TERMINATION HOSE AS YOU CONNECT.

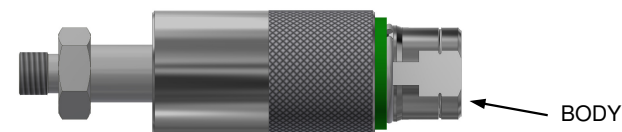

OPERATING INSTRUCTIONS / MAIN SEAL REPLACEMENT

NOTE: DO NOT FORCE CONNECTOR ONTO TEST PART WHEN CONNECTING. THE SPLIT COLLET SHOULD EASILY MATE WITH TEST PIECE. FORCING THE CONNECTOR WILL RESULT IN POOR SEALING AND POSSIBLE LEAKAGE. DO NOT TURN OR ROTATE CONNECTOR AFTER THE COLLETS HAVE GRIPPED TEST PART. DAMAGE TO TEST PIECE AND THE CONNECTOR'S INTERNAL PARTS MAY RESULT.

3. Make sure green ring indicator is exposed as shown.

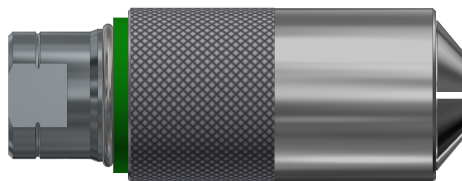

4. Tug on the connector to assure proper engagement and gripping before introduction of pressurized media.
5. Activate test media through connector back port. Pressure will enhance the seat.
6. To disconnect from test piece, deactivate test pressure. Slide knurled sleeve away from test piece to expand collets. Remove connector from test piece.

MAIN SEAL REPLACEMENT:

NOTE: IN MOST CASES THE MAIN SEAL CAN BE EXTRACTED AND REPLACED IN THE STEPS THAT FOLLOW. IF CONNECTOR MUST BE DIS-ASSEMBLED TO REPLACE MAIN SEAL, SEE INSTRUCTION WP122.

1. Slide sleeve back allowing collets/jaws to open. This will help expose the end of the piston to extract main seal.

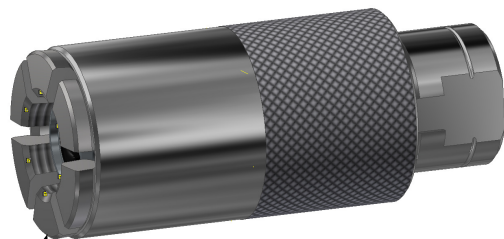

COLLET/JAWS
OPEN

2. Using a pick like tool or small flat blade screwdriver, remove main seal from piston and discard.
3. Use caution not to scratch the main seal groove surfaces in piston.

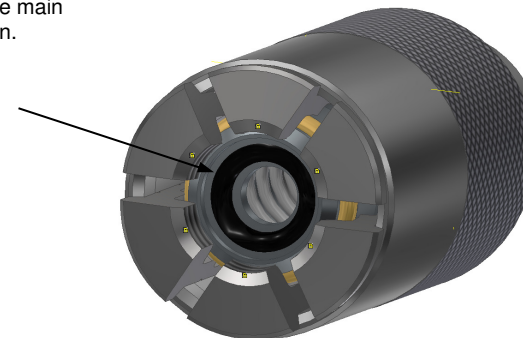

4. Install new main seal using your fingers or a non-marring tool. **DO NOT LUBRICATE!**
5. Make sure main seal is properly seated.

CAUTION: 60 & 70 Connectors are not internally valved. Disconnecting while pressurized can cause rapid separation and high velocity loss of media.

MAINTENANCE:

- Periodically inspect connector and seal for proper operation. Repair or replace parts as required to assure positive sealing and performance.
- Establish a regular interval for lubrication. The media and environment will be determining factors in establishing this interval to prevent dryness and/or corrosion.
- Difficulty of operation after continual use indicates need for lubrication or other maintenance. Repair parts, instructions and tools are available. Please contact your *FasTest* Distributor or the factory for assistance.

FasTest, Inc. Product Warranty

FasTest, Inc. warrants its products against defects of workmanship and/or material for 1 YEAR from the date of the sale by FasTest, Inc. This warranty is void if the product is misused, tampered with, or used in a manner that is not in accordance with FasTest, Inc. recommendations and/or instructions. FasTest, Inc. is not liable for consequential or other damages including, but not limited to, loss, damage, personal injury, or any other expense directly or indirectly arising from the use of or inability to use its products either separately or in combination with other products. ALL OTHER WARRANTIES EXPRESSED OR IMPLIED, WHETHER ORAL OR WRITTEN, INCLUDING BUT NOT LIMITED TO WARRANTIES OR MERCHANTABILITY OR FITNESS FOR A PARTICULAR PURPOSE ARE EXPRESSLY EXCLUDED.

Remedy under this warranty is limited to replacement of the product or an account credit in the amount of the original selling price, at the option of FasTest, Inc. All allegedly defective products must be returned prepaid transportation to FasTest, Inc. along with information describing the products performance, unless disposition in the field is authorized in writing by FasTest, Inc.