

REPAIR/REBUILD INSTRUCTIONS

Page 1 of 3



60V & 70V Series Valve Connector Repair

DESCRIPTION: Basic Rebuild Instructions for 60 & 70 Valve Connectors for Sealing Male Threads and Formed Tube Ends.

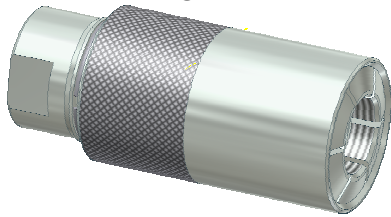

Please thoroughly read these rebuild instructions prior to disassembling the connector. This connector is designed to provide a safe, reliable leak-tight seal and connection when properly maintained and operated.

DO NOT EXCEED pressure rating as marked on connector or corresponding literature. Before using, verify that this pressure rating is within your working pressures.

FOR REFERENCE SEE WP144, 60V/70V OPERATING INSTRUCTIONS.

DISASSEMBLY:

Note: Before you discard any parts, make sure the rebuild kit has a new replacement to match!!

1. Slide sleeve forward and remove large snap ring.

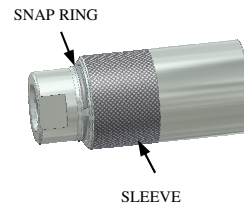

2. Upon snap ring removal, the stop ring and large spring will come out from under the sleeve.

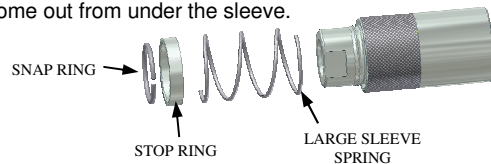

3. Slide sleeve off in same direction as large spring. As sleeve slides away from connector squeeze hand around collets. There might be a slight resistance to completely slide sleeve from collets. Squeeze and un-squeeze collets as sleeve is pulled away from collets.

Note: Caution, Piston inside collets is under spring pressure. Piston might want to push out of collets.

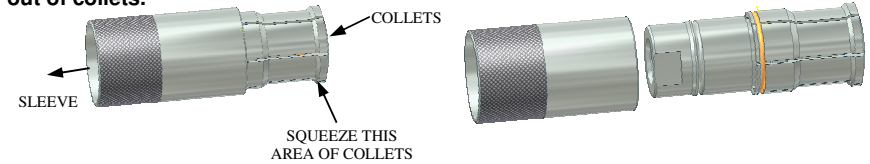

4. Piston is contained within the collets, remove collets and collet o-ring.

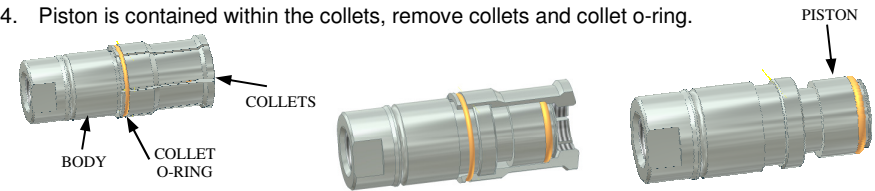

5. Remove o-rings from body and outside of piston. NOTE; DO NOT REMOVE MAIN SEAL FROM PISTON. MAIN SEAL PACKS ARE SOLD SEPARATELY.

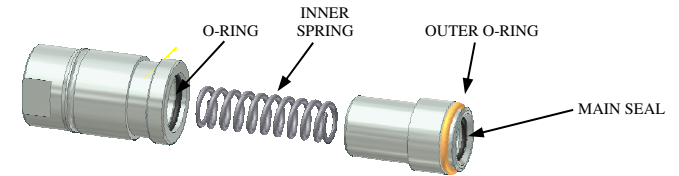

6. Remove inner piston components and discard o-rings.

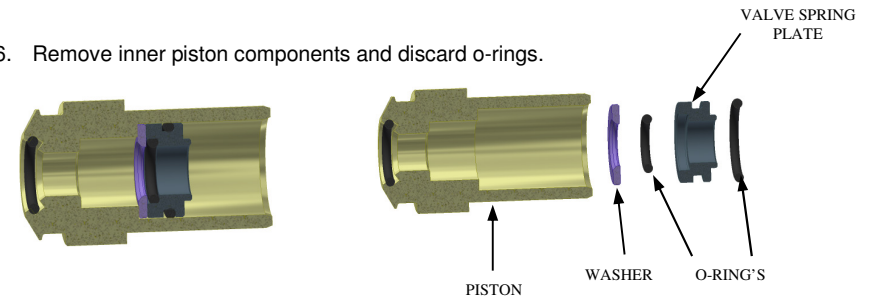

7. Clean all parts prior to re-assembly.



www.fastestinc.com
Roseville, MN
Toll Free at 1-800-444-2373
Fax 651-645-7390
WP143 Rev B 6/25/2021

REPAIR/REBUILD INSTRUCTIONS

Page 2 of 3

REASSEMBLE:

Note: Use all new seals, springs, snap rings etc... that are provided. Lightly lubricate seals with petroleum jelly.

1. Place new o-rings into body and onto piston.

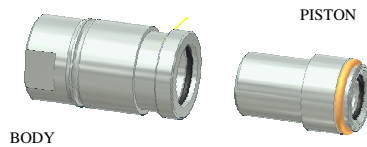

2. PAY CLOSE ATTENTION TO WASHER AND VALVE SPRING PLATE INSTALLATION INTO PISTON. INNER CHAMFER SIDE OF WASHER GOES INTO PISTON FIRST. LUBE AND PLACE O-RINGS OVER AND INSIDE THE VALVE SPRING PLATE.

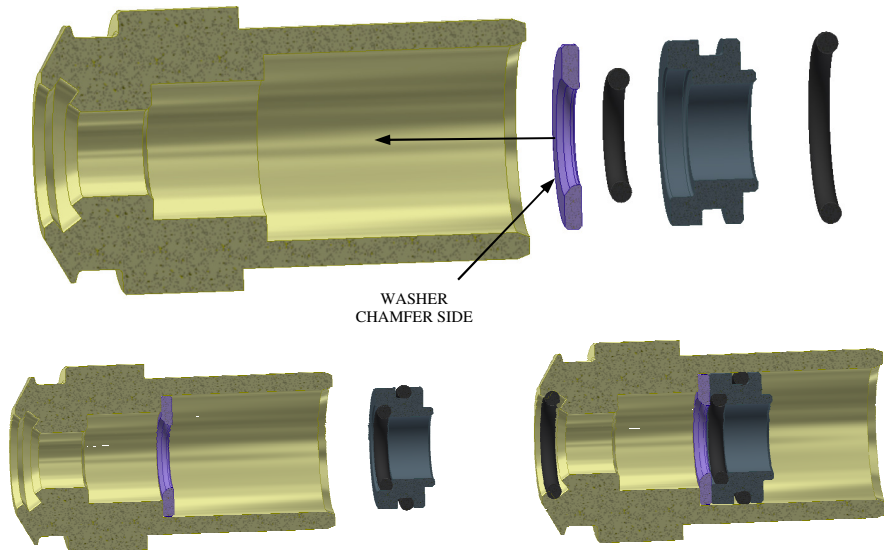

3. Place collets around body, use new collet o-ring to hold collets in place.

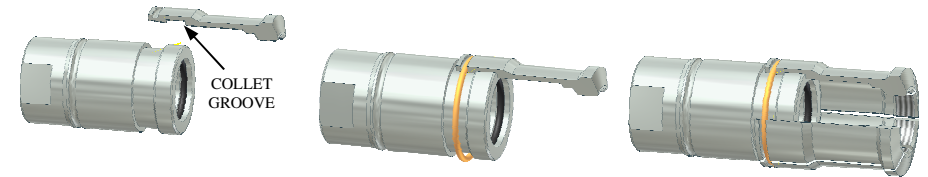

4. Note: Threaded collets must be placed in order around body, according to spiral timing groove on outside of collet segments.

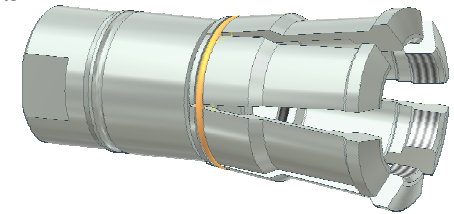

5. Open collets far enough to place new inner piston spring down inside body, then press piston down inside collets. Might help to stand up vertically on work surface.

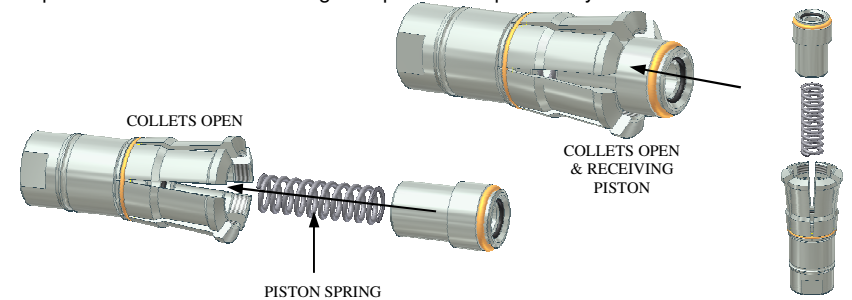

6. With piston down inside collets, hold collets closed with free hand.

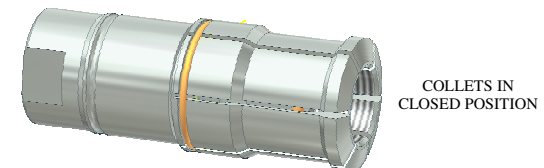

REPAIR/REBUILD INSTRUCTIONS

Page 3 of 3

7. Slide sleeve over body and over collets. Slide on far enough to expose snap ring groove.

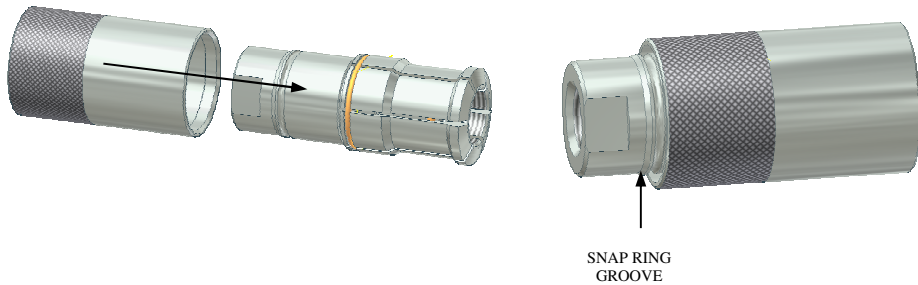

8. Place assembly with collets down on work surface. Using stop ring, push new large sleeve spring down over body, followed by stop ring and the new snap ring.

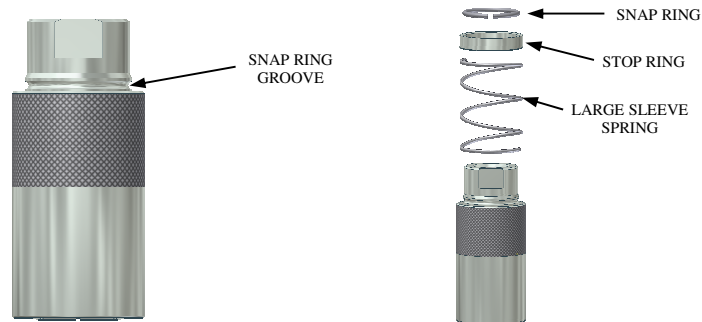

9. Using some type of arbor press or hand tool, press the snap ring into snap ring groove on body. Work press around snap ring until it snaps into groove. When snap ring is properly seated the stop ring will be inside sleeve.

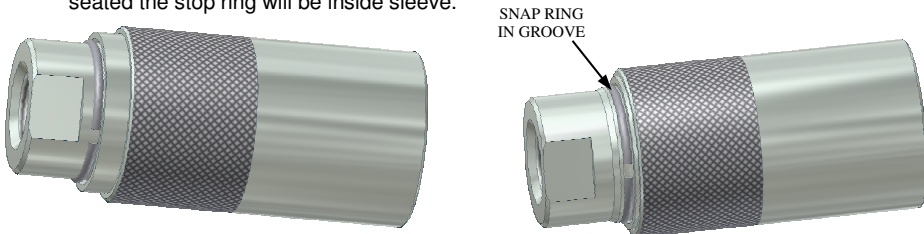

10. Before applying test pressure to connector, actuate connector several times onto test piece to ensure proper function and movement of the collets.

FasTest, Inc. Product Warranty

FasTest, Inc. warrants its products against defects of workmanship and/or material for 12 months from the date of the sale by FasTest, Inc. This warranty is void if the product is misused, tampered with or used in a manner that is not in accordance with FasTest, Inc. recommendations and/or instructions. FasTest, Inc. is not liable for consequential or other damages including, but not limited to, loss, damage, personal injury, or any other expense directly or indirectly arising from the use of or inability to use its products either separately or in combination with other products. ALL OTHER WARRANTIES EXPRESSED OR IMPLIED, WHETHER ORAL OR WRITTEN, INCLUDING BUT NOT LIMITED TO WARRANTIES OR MERCHANTABILITY OR FITNESS FOR A PARTICULAR PURPOSE ARE EXPRESSLY EXCLUDED.

Remedy under this warranty is limited to replacement of the product or an account credit in the amount of the original selling price, at the option on FasTest, Inc. All allegedly defective products must be returned prepaid transportation to FasTest, Inc. along with information describing the products performance, unless disposition in the field is authorized in writing by FasTest, Inc.