

60V & 70V Series Valve Connectors

DESCRIPTION: Sleeve Activated Connectors for Sealing Male Threads and Formed Tube Ends.

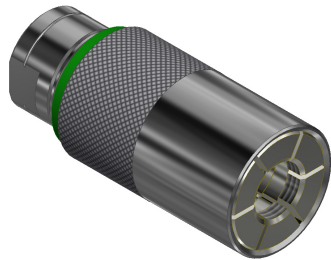

60 Series for
Male Threads

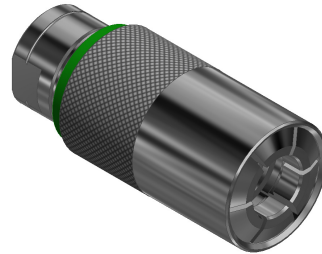

70 Series for Tube
Configurations

CAUTION: 60V & 70V Connectors are internally valved. Disconnecting while pressurized can cause rapid separation. Termination pressure should be relieved prior to disconnecting connector. Connecting while pressurized is doable but not recommended. Example of connection forces; At 80psi with a Body Size 3 connector the force to connect is approximately 44 lbs. Body Size 4 connector is approximately 56 lbs. at 80psi.

Please thoroughly read the instructions prior to operating the connector. This connector is designed to provide a safe, reliable leak-tight seal and connection when properly maintained and operated.

- The connector is designed to mate with a specific application. Verify the application prior to the introduction of pressure or processing. Use only in a safe environment. Safety chains and guards are recommended for all applications.
- Connectors are NOT designed for permanent connections and are for temporary connections only.

DO NOT EXCEED pressure rating as marked on connector or corresponding literature. Before using, verify that this pressure rating is within your working pressures.

- Installation
- Operation
- Main Seal Replacement
- Connector Maintenance
- Safety Warnings - Guidelines

INSTALLATION:

1. Connect media hose/fitting to the termination port on connector.
 - a. Pipe tape and or thread sealant is recommended.

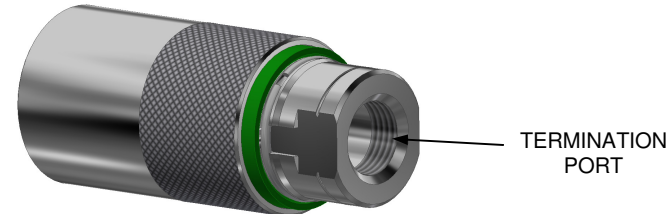

OPERATION:

1. Slide sleeve back and collets will open.

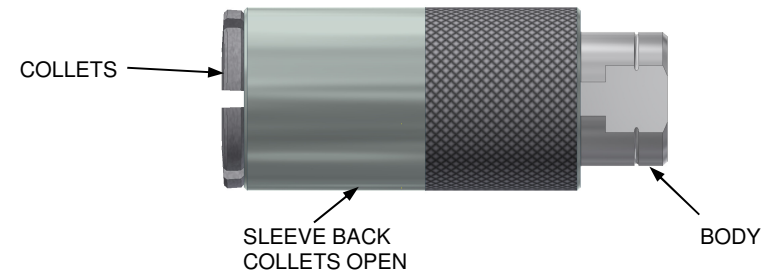

2. Insert male end of the component to be tested into collets and press against connector. Spring action forces knurled sleeve forward, collapsing collets to the gripping and sealing position.
3. **Note to Operator; The Type 60/70 Connector will connect better when you do the following. Hold exposed area of Body at termination end of connector. Try to keep hands free from the sleeve as you connect to your test piece.**

4. Attempting to connect while connector is still pressurized is doable but not recommended.

NOTE: DO NOT FORCE CONNECTOR ONTO TEST PART WHEN CONNECTING. THE COLLETS SHOULD EASILY MATE WITH TEST PIECE. FORCING THE CONNECTOR WILL RESULT IN POOR SEALING AND POSSIBLE LEAKAGE. DO NOT TURN OR ROTATE CONNECTOR AFTER THE COLLETS HAVE GRIPPED TEST PART. DAMAGE TO TEST PIECE AND THE CONNECTOR'S INTERNAL PARTS MAY RESULT.

5. When connector is properly connected the green indicator ring will be visible.
 - a. Tug on the connector near the termination port to assure proper engagement and gripping before introduction of pressurized media.

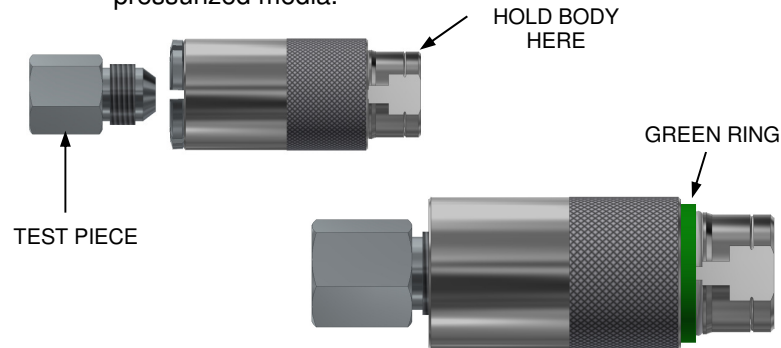

6. Activate test media through connector termination port. Pressure will enhance the seal.
7. To disconnect from test piece, deactivate test pressure. Slide knurled sleeve away from test piece to expand collets. Remove connector from test piece.

MAIN SEAL REPLACEMENT:

NOTE: IN MOST CASES THE MAIN SEAL CAN BE EXTRACTED AND REPLACED IN THE STEPS THAT FOLLOW. IF CONNECTOR MUST BE DIS-ASSEMBLED TO REPLACE MAIN SEAL, SEE INSTRUCTION WP143.

1. Slide sleeve back allowing collets/jaws to open. This will help expose the end of the piston to extract the main seal.

SLEEVE BACK,
JAWS OPEN

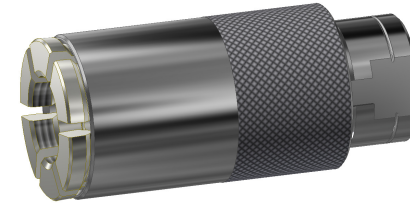

2. Using a pick like tool or small flat blade screwdriver, remove the main seal from piston and discard.
3. Use caution not to scratch the main seal groove surfaces in piston.

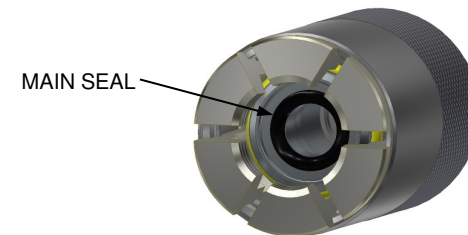

4. Install new main seal using your fingers or a non-marring tool. DO NOT LUBRICATE NEW SEAL!
5. Make sure main seal is properly seated.

MAINTENANCE:

- Periodically inspect connector and seal for proper operation. Repair or replace parts as required to assure positive sealing and performance.
- Establish a regular interval for lubrication. The media and environment will be determining factors in establishing this interval to prevent dryness and/or corrosion.
- Difficulty of operation after continual use indicates need for lubrication or other maintenance. Repair parts, instructions and tools are available. Please contact your *FasTest* Distributor or the factory for assistance.

Safety Warnings – Guidelines:

- If instructions are not completely understood by operator or components are missing, contact **FasTest** before attempting use of the connector.
- Application Safety: All **FasTest** products have been designed with safety in mind; however, it is the responsibility of the user to design each process in such a way to avoid mishaps that can cause physical hazard or property loss. Secondary restraints such as safety chains, shields, cages, or fixtures are all good choices depending on the application. **FasTest** can recommend or assist you in clarifying potential hazards of your application.
- **FasTest 60/70 Series Valve** connectors are internally valved to prevent loss of media when disconnected. FasTest recommends that any connection or disconnection be made only when pressure is reduced to ambient.
- **FasTest 60/70 Series Valve** connectors must only be used with test pieces of a specific size as indicated by the part number. Improper use may separate the connector from the test piece resulting in physical harm or damage.

FasTest, Inc. Product Warranty

FasTest, Inc. warrants its products against defects of workmanship and/or material for 12 months from the date of the sale by FasTest, Inc. This warranty is void if the product is misused, tampered with, or used in a manner that is not in accordance with FasTest, Inc. recommendations and/or instructions. FasTest, Inc. is not liable for consequential or other damages including, but not limited to, loss, damage, personal injury, or any other expense directly or indirectly arising from the use of or inability to use its products either separately or in combination with other products. ALL OTHER WARRANTIES EXPRESSED OR IMPLIED, WHETHER ORAL OR WRITTEN, INCLUDING BUT NOT LIMITED TO WARRANTIES OR MERCHANTABILITY OR FITNESS FOR A PARTICULAR PURPOSE ARE EXPRESSLY EXCLUDED.

Remedy under this warranty is limited to replacement of the product or an account credit in the amount of the original selling price, at the option on FasTest, Inc. All allegedly defective products must be returned prepaid transportation to FasTest, Inc. along with information describing the products performance, unless disposition in the field is authorized in writing by FasTest, Inc.